

Universal End Wall Model# 4040BWST

for

**Single Truss Container Shelter
40'x40'x15'(W12xL12xH4.5m)**

Assembly Instructions

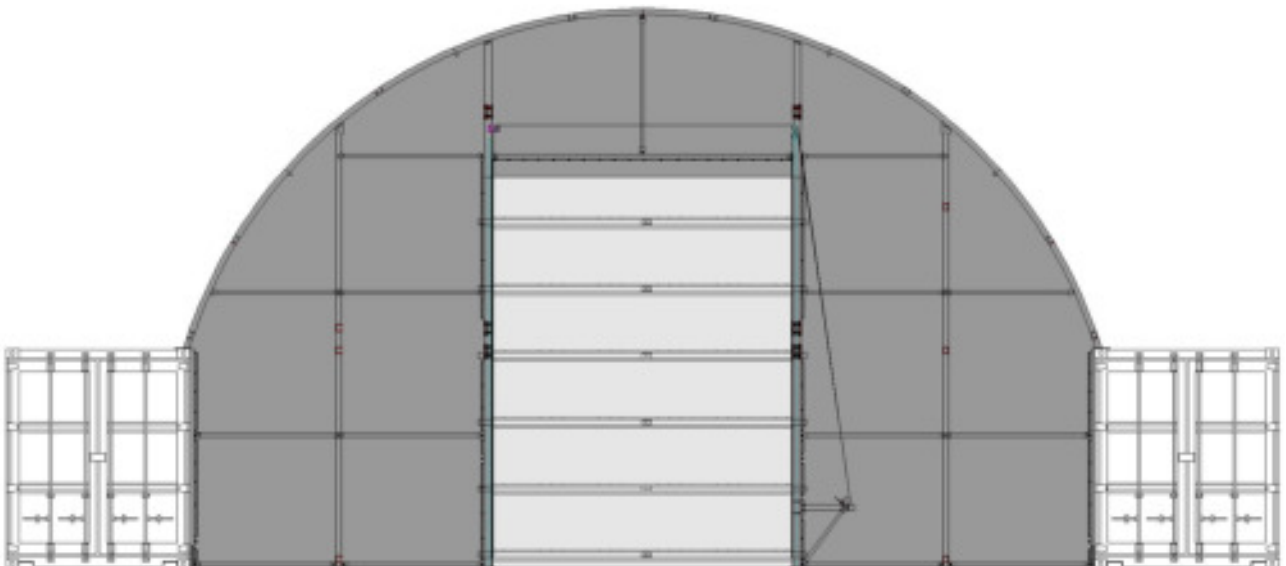

RECOMMENDED TOOLS

Equipment List

Speed Wrench 22#.23#.24#	
Hammer (30lb)	
Rope (12#)	
Long Tape (50m)	
Hammer Drill*1	
Lifter*2	
Crane*1	
Forklift*1	
Protective equipment	

YOU MUST READ THIS DOCUMENT BEFORE YOU BEGIN TO ASSEMBLE THE SHELTER.

Thank you for purchasing our shelter. When properly assembled and maintained, this product will provide years of reliable service. These instructions include helpful hints and important information needed to safely assemble and properly maintain the shelter. Please read these instructions **before** you begin.

If you have any questions during the assembly, please contact local dealer for assistance.

SAFETY PRECAUTIONS

- . Wear eye protection.
- . Wear head protection
- . Wear gloves when handling metal tubes
- . Use a portable GFCI (Ground Fault Circuit Interrupter) when working with power tools and cords.
- . Do not climb on the shelter or framing during or after construction.
- . Do not occupy the shelter during high winds, tornadoes, or hurricanes.
- . Provide adequate ventilation if the structure is enclosed.
- . Do not store hazardous materials in the shelter.
- . Provide proper ingress and egress to prevent entrapment.

ANCHORING INSTRUCTIONS

Prior to assembling this shelter, please read the **MUST READ** document included with the shipment.

⚠ WARNING: The anchor assembly is an integral part of the shelter construction. Improper anchoring may cause shelter instability and failure of the structure. Failing to anchor the shelter properly **will void the manufacturer's warranty** and may cause serious injury and damage.

LOCATION

Choosing the proper location is an important step before you begin to assemble the structure.

The following suggestions and precautions will help you determine whether your selected location is the best location.

- . Never erect the structure under power lines.
- . Identify whether underground cables and pipes are present **before** preparing the site or anchoring the structure.
- . Location should be away from structures that could cause snow to drift on or around the building
- . Do not position the shelter where large loads such as snow and ice, large tree branches, or other overhead obstacles could fall.
- . Your shelter's cover can be quickly removed and stored prior to severe weather conditions. If strong winds or severe weather is forecast in your area, we recommend removal of cover.

SITE













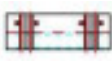

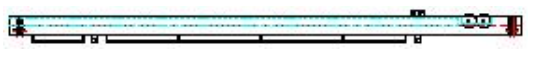
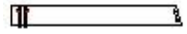

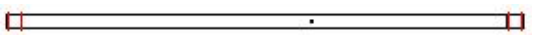
After choosing a location, proper preparation of the site is essential. The following site characteristics will help ensure the integrity of the structure.

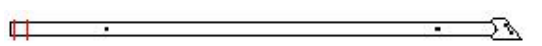
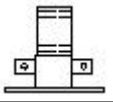

















- . The support structure must be level to properly and safely erect and anchor the frame.
- . Drainage: Water draining off the structure and from areas surrounding the site should drain away from the site to prevent damage to the site, the structure, and contents of the structure.

⚠ WARNING: The individuals assembling this structure are responsible for designing and furnishing all temporary bracing, shoring and support needed during the assembly process. For safety reasons, those who are not familiar with recognized construction methods and techniques **must seek the help of a qualified contractor.**

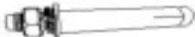
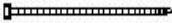
Universal End Wall with winch door for Single Truss Container Shelter W12xL12xH4.5m

Parts List

Part Code	Description		Qty/ PCS
21	left lower post welded with door track		1
22	right lower post welded with door track		1
23	middle post welded with door track (extension for high cube container)		2
24	left upper post welded with door track and pulley		1
25	right upper post welded with door track and pulley		1
26	upper post		2
27	connection plate for post		6+6
28	interior lower post		2
29	interior middle post (extension for high cube container)		2
30	interior upper post, left & right		2
30A	base plate		2
31	cross beam, 2pcs/set		1 set
32	vertical rod		1
33	rail		2
34	rail		8
35	rail		4
36	side square tube (left & right) with velcro		2
37	side square tube with velcro (extension for high cube container)		2
38	angle bracket		1

39	door winch bracket		1
40	support tube for winch bracket		1
41	pole for door opening		1
42	door bracing tube 2pcs/set		5 sets
43	bottom bracing tube with hole 2pcs/set		1 set
44	tube clip with bolt		10
45	bolt M12x130 for post		26
46	bolt M10x70 for post		25
47	bolt M10x30 for connection plate		22
48	bolt M10x90 for swaged tube		12
49	carriage bolt M11x100 for rail		6
50	bolt M8x70 for rail		2
51	bolt M6x40 for door bracing tube No.42, No.43		6
52	expansion bolt		16
53	cable tie		60
54	rope, 5 bundles		2 packs
55	steel wire rope		1 bundle
56	steel wire clamp		4
57	door winch		1
58	front cover		1

Note: End Wall shall be installed according to the dimensions indicated in mm (millimeter) in the drawing. The dimensions indicated in feet are for reference only.

FRAME INSTALLATION

Installation for End Wall Basing on 40ft standard container (2.6m, 8'6" high)

Winch door size: W4.0xH4.88m (13ftx16ft)

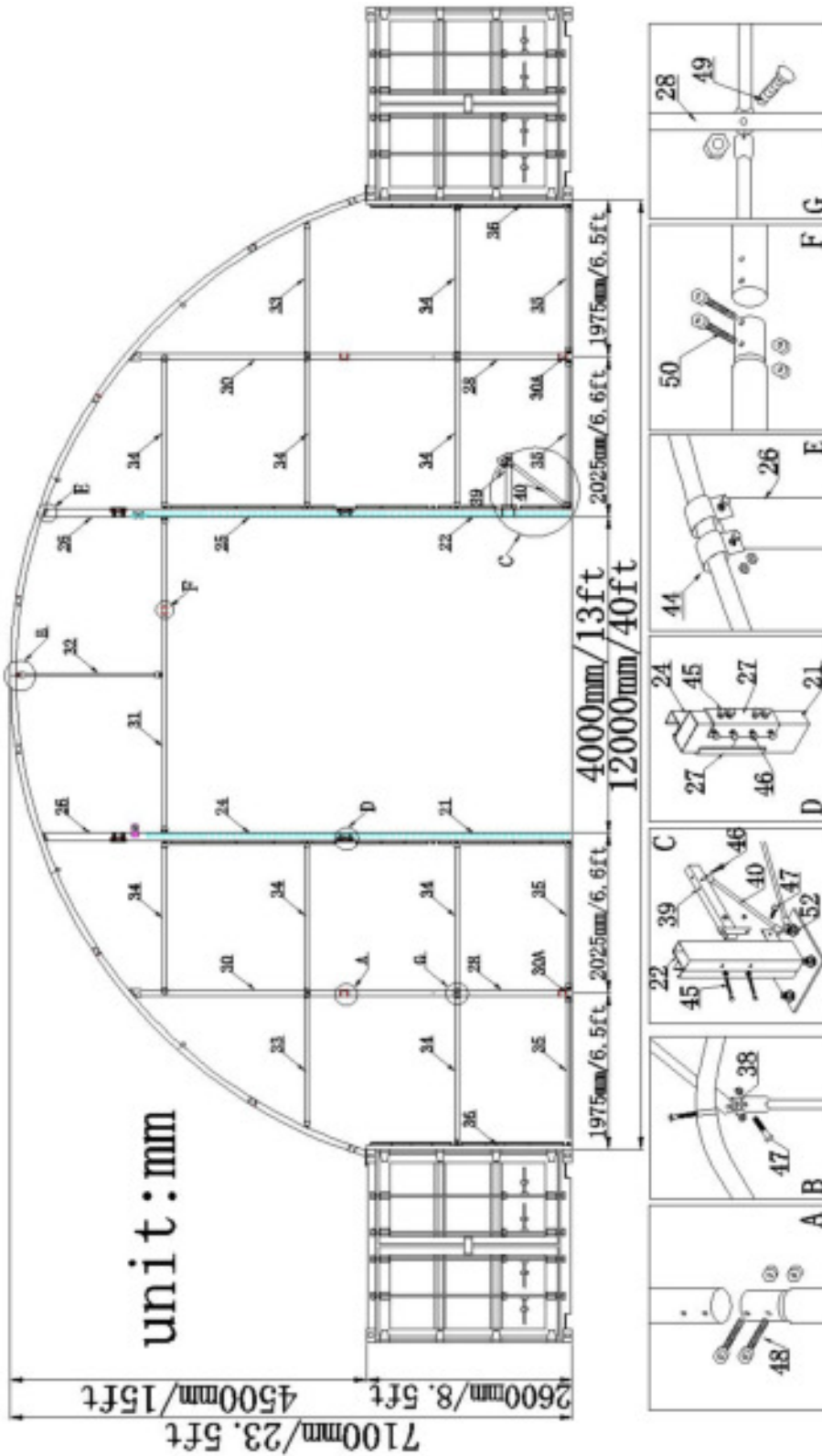

Installation for End Wall Basing on 40ft high cube container (2.9m, 9'6" high)

Winch door size: W4.0xH5.18m (13ftx17ft)

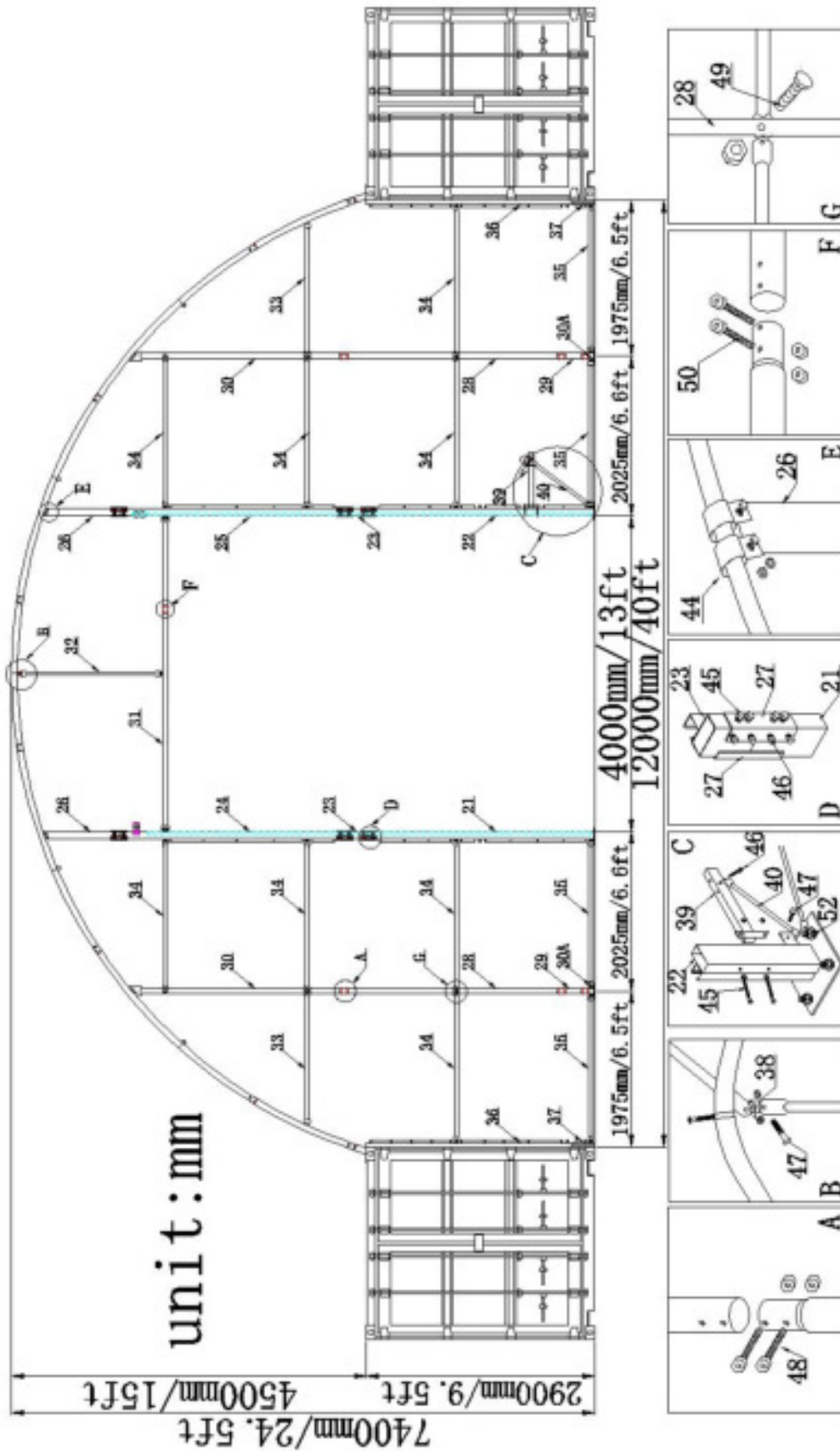

WINCH DOOR INSTALLATION

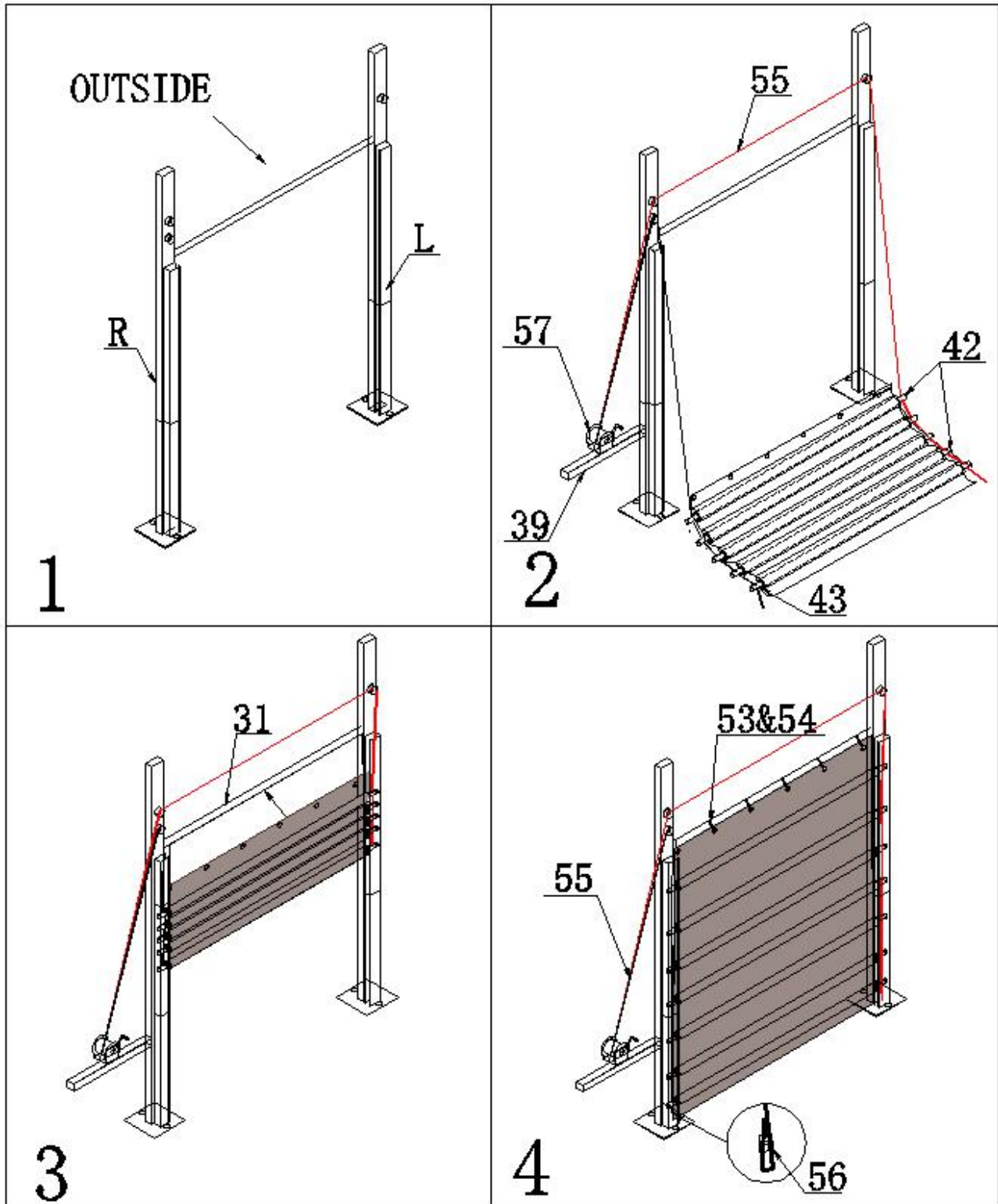

1. Install the front door frame and door winch bracket
2. Fix the winch to the bracket. Make sure the winch handle faces the outside. Refer to Figure 1.

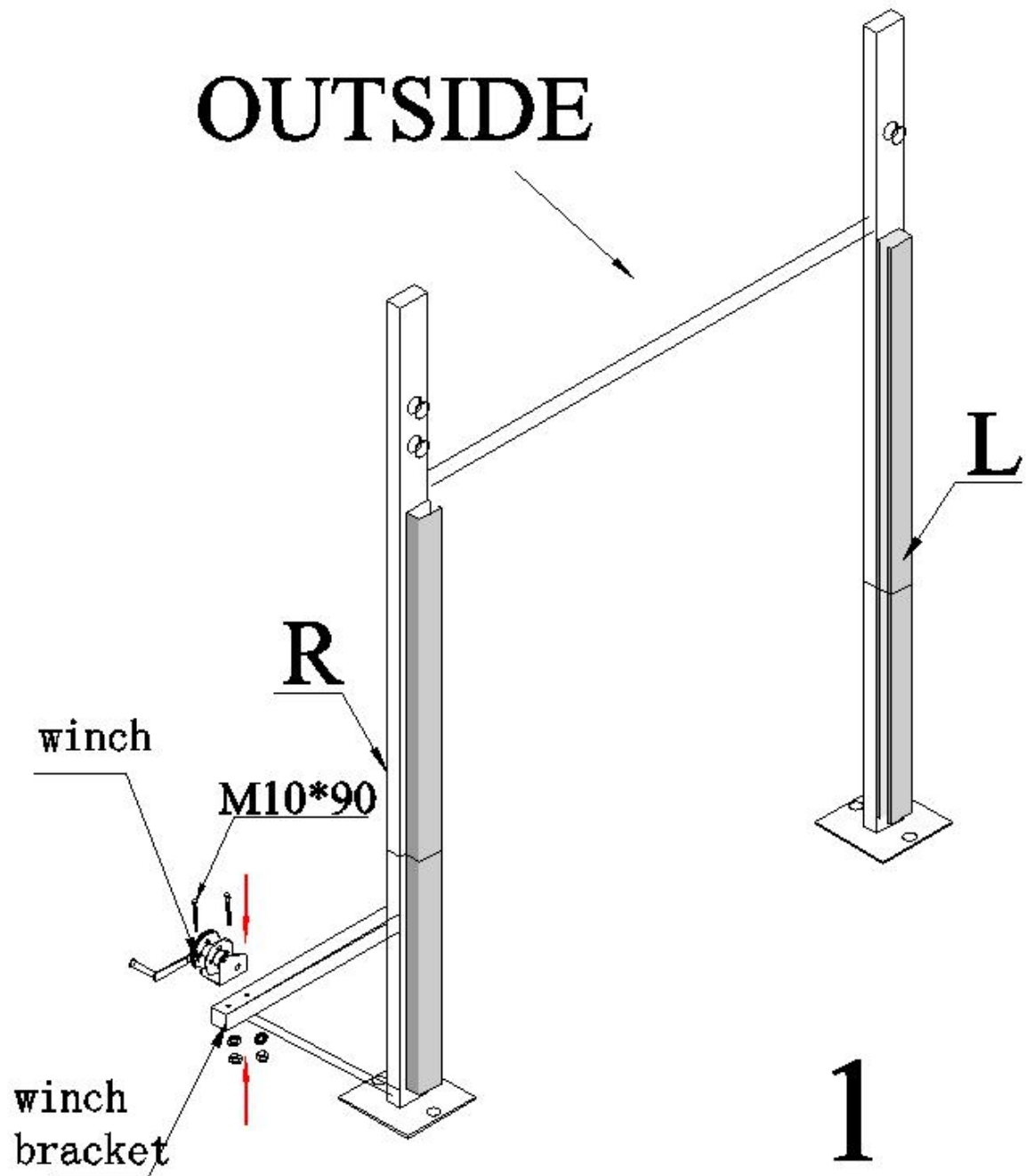

3. Take out the door curtain cloth and lay it on the ground. Pay attention to the direction. The side with pipe pockets faces inward.

4. Connect the door bracing tube (2pcs/set) with M6x40 bolt.

5. Thread the door bracing tube into the pocket from top to bottom. Pay attention to the bottom bracing tube. There are holes on both sides for fixing steel wire rope. Refer to Figure 2.

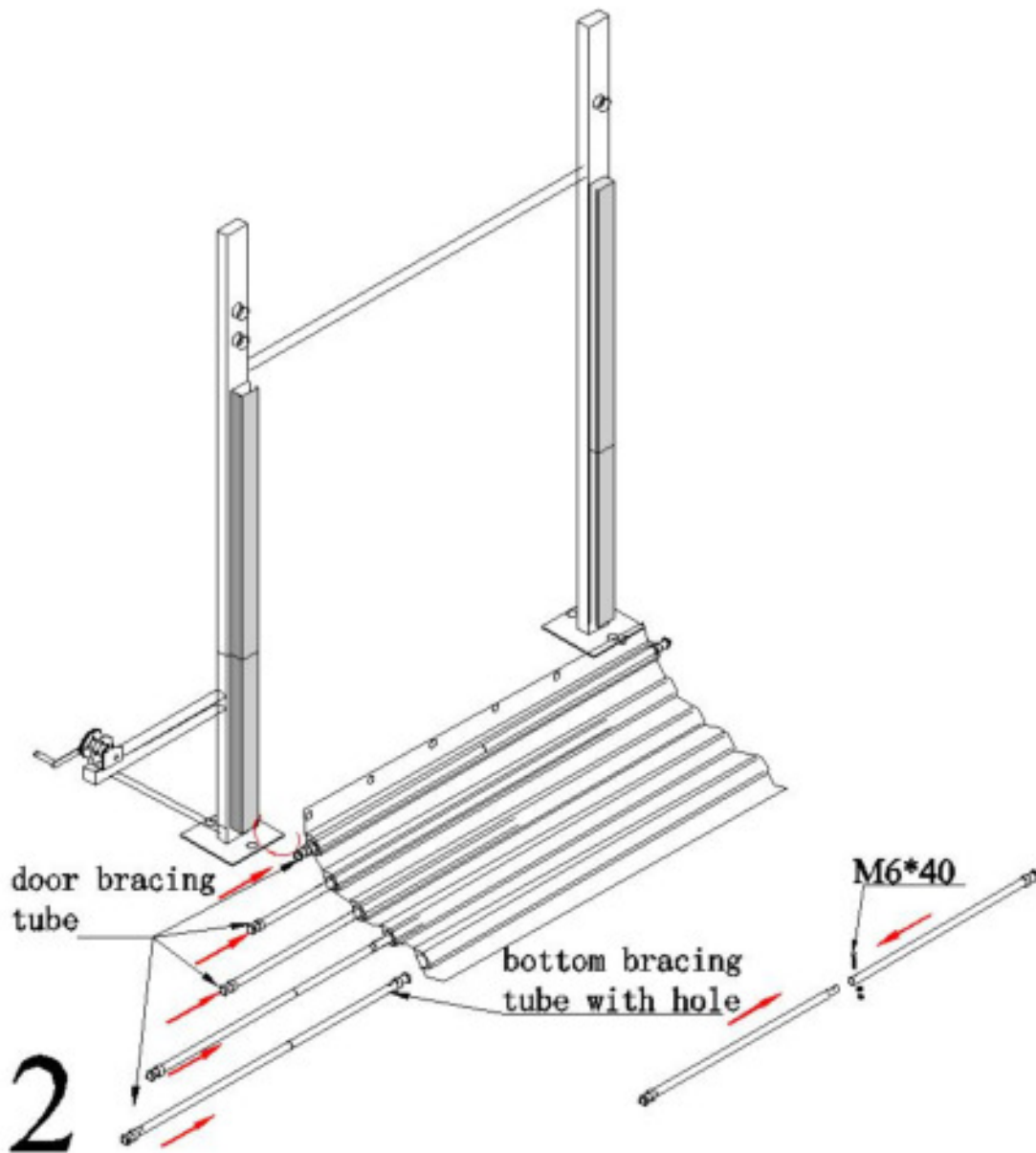

6. Put the steel wire rope through the pulley on the door frame as shown in Figure 3, so that the steel wire rope is located on the inner side of the door frame and on the same plane as the pulley, and then the steel wire rope sags naturally. Keep the length of both sides equal, and naturally sag to the ground.
7. Fix each end of steel wire rope to the hole on bottom bracing tube with steel wire clamps. Make sure fix it firmly.
8. Put the door bracing tube into the track from the gap at the bottom, from top to bottom.

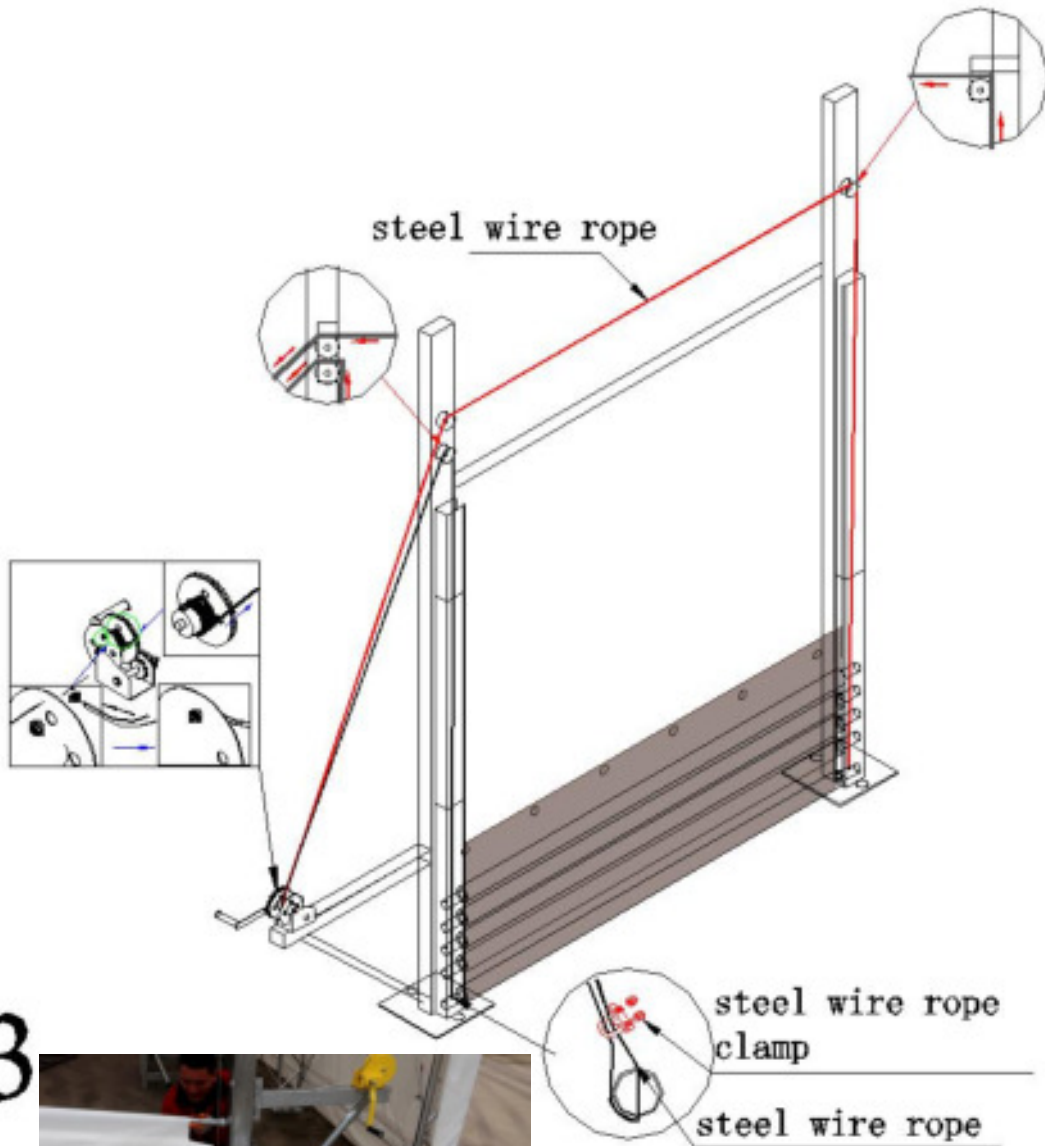

3



9. Adjust the length of the steel wire rope to be equal on both sides. Fix the wire rope fold to the hole in the winch. Refer to Figure 4.

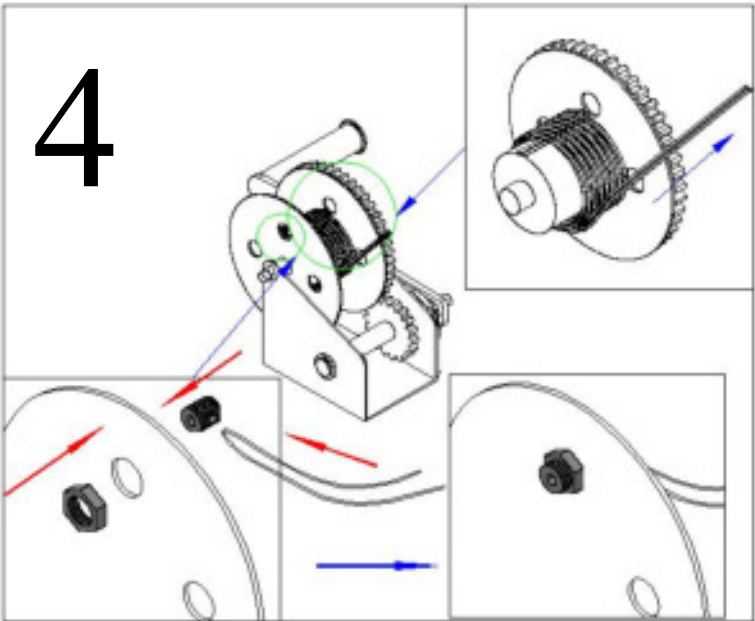

10. Turn the winch clockwise to lift the door curtain cloth and bracing tubes to a position about 40-50cm away from the cross beam. Lace the eyelets on the cloth to cross beam with a rope. Refer to Figure 5.

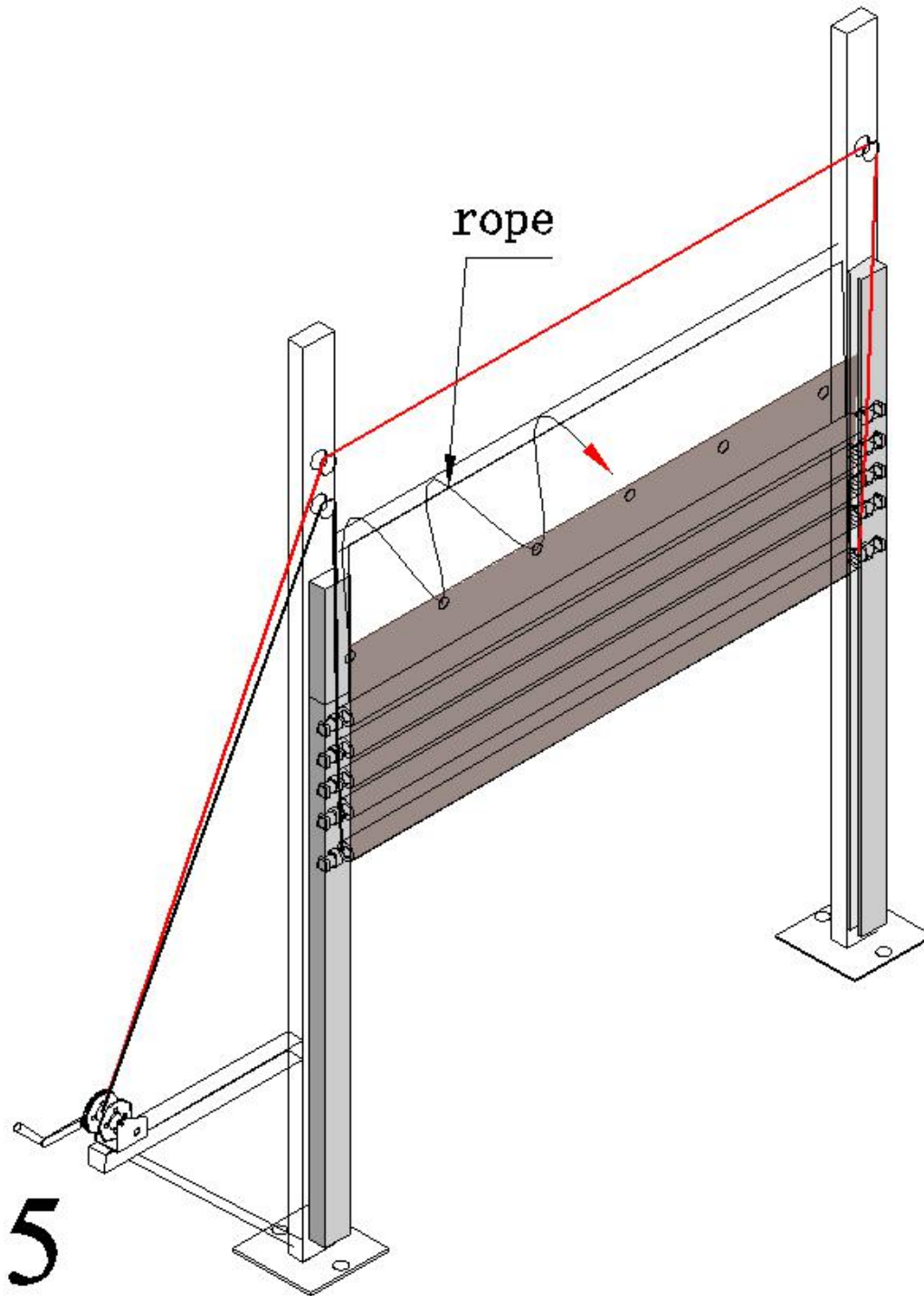

11. Now the winch door installation is completed. Turn the winch clockwise to raise and counterclockwise to lower the door. The steel wire rope shall be evenly wound on the winch so that the door can rise and fall smoothly.

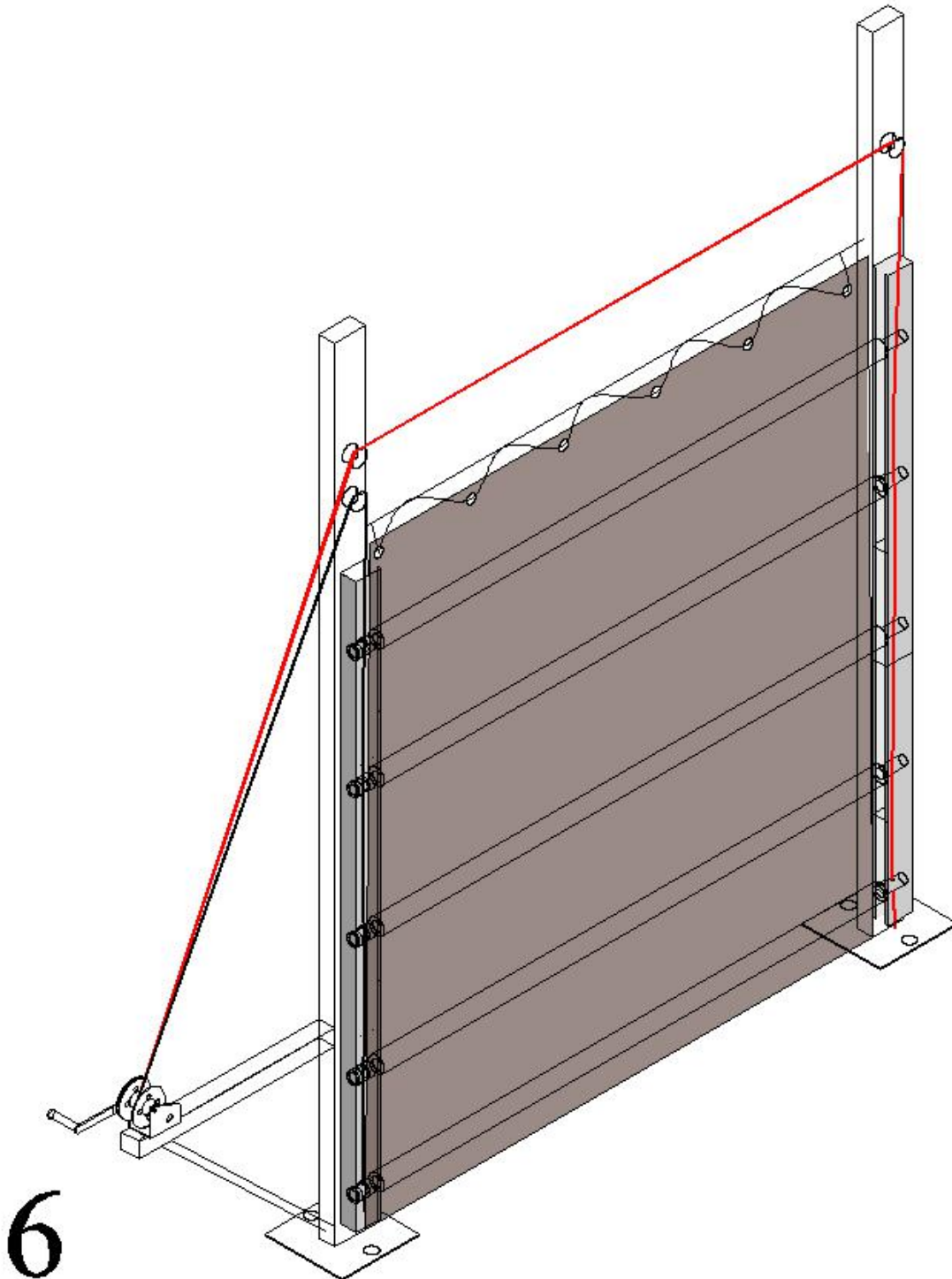

COVER INSTALLATION

Installation for End Wall Basing on 40ft standard container (2.6m, 8'6" high)

Winch door size: W4.0xH4.88m (13ftx16ft)

Note: Need to put the bottom bracing tube(No.43) into the second last row of pocket.

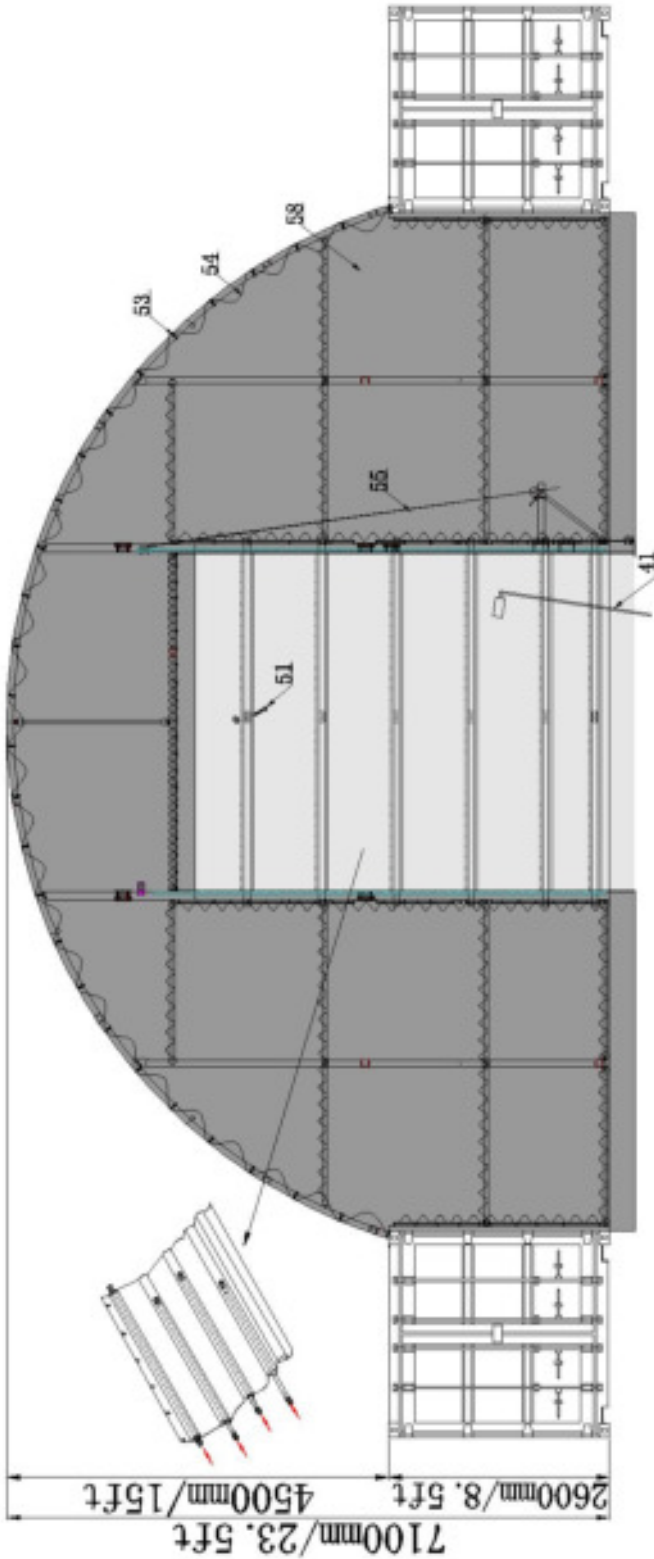

Installation for End Wall Basing on 40ft high cube container (2.9m, 9'6" high)

Winch door size: W4.0xH5.18m (13ftx17ft)

Note: Need to put the bottom bracing tube(No.43) into the bottom pocket.

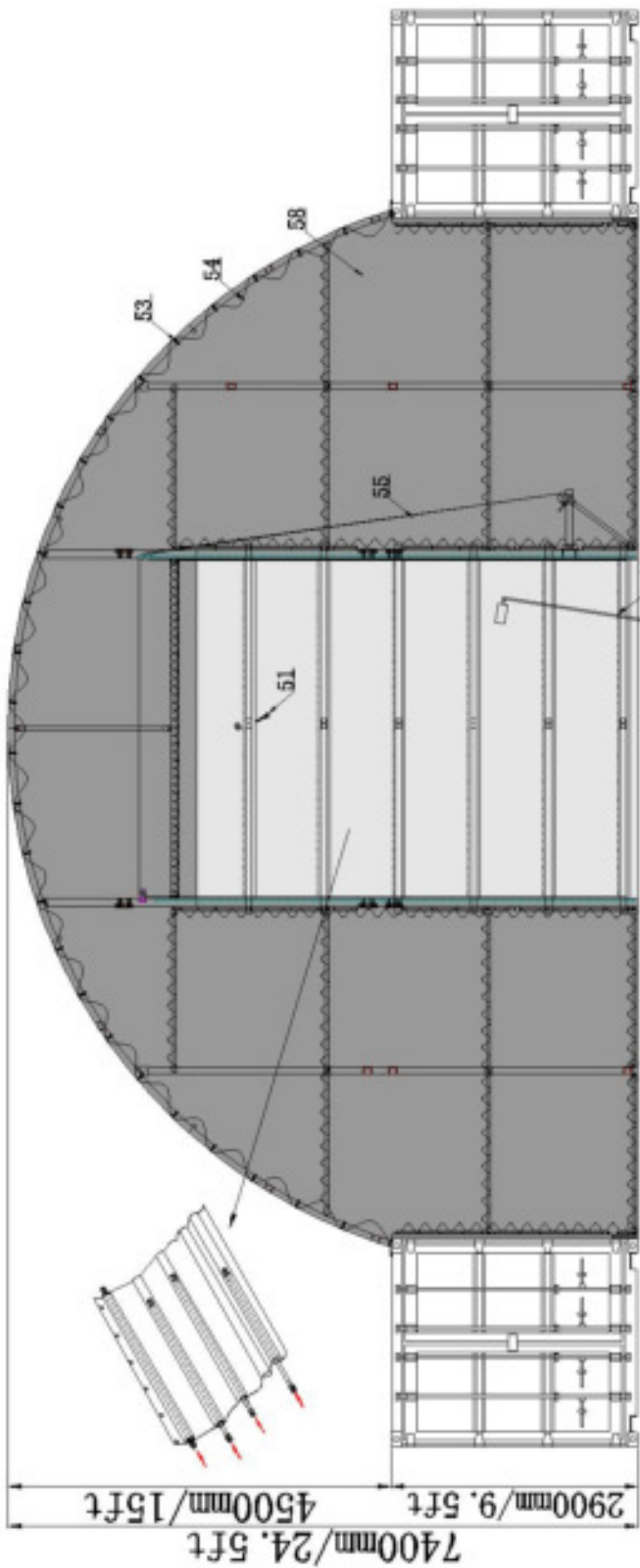

Now your assembly is completed.