



990 U.S. 27 Venus, FL 33960 United States
sales@storageandcanopy.com
+1 (321) 710-0804
www.storageandcanopy.com

**Shipping Container Roof
Single Truss Round Style
Model# C3340R 33'x40'x12'
(6'7" arch space)
Assembly Instructions**



Equipment List

<p>Speed Wrench 22#.23#.24#</p>	
<p>Hammer (30lb)</p>	
<p>Rope (12#)</p>	
<p>Long Tape (50m)</p>	
<p>Hammer Drill*1</p>	
<p>Lifter*2</p>	
<p>Crane*1</p>	
<p>Forklift*1</p>	
<p>Protective equipment</p>	

ANCHORING THE CONTAINER

Make sure you have:

- Welder.
 - Cement.
 - Four 3" x 3" x 6 feet 1/4" Square steel angle
1. As shown in the diagram 1, make a 3 ft deep hole right beside one of the front and opposite rear corners of the container, in which the 6ft square steel will be installed.
 2. Insert the 6ft square steel into the hole, making sure 3ft is below the surface completely laying on the side of the containers.
 3. Weld the square steel to the 2 containers.
 4. Pour cement in the holes to make sure the square steel won't move.
 5. Repeat the previous steps on the corners located in the opposite rear side.

Securing the containers to the floor is crucial, that way the containers won't shift under harsh weather conditions, thus avoiding the shipping container canopy roof top of getting damaged.

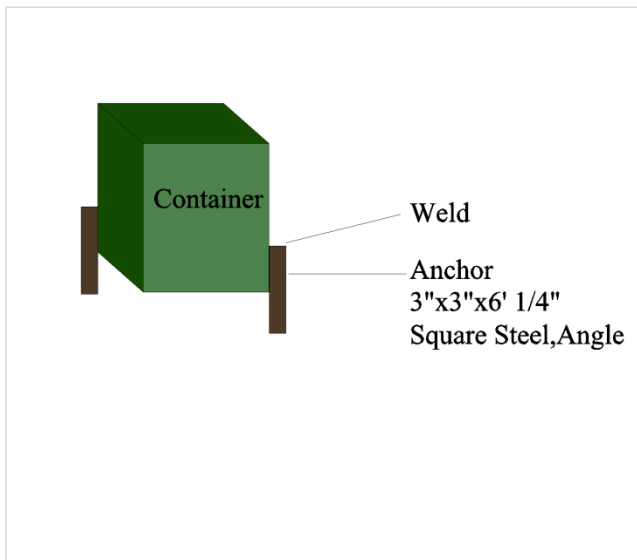

Diagram 1



Highly Recommended

1. All container canopy covers need to be removed during windstorm of 60 mph, leaving frame assembled. **Customer responsibility.**
2. All container canopy covers need to be removed before a snowstorm of 1-2 inches (for single truss Shipping container roofs) and 3-4 inches (for double truss Shipping container roofs), leaving the frame assembled. **Customer responsibility.**
3. It is highly recommended for customers who live in snow states and cities to use double truss framing instead of Single truss framing. **Customer responsibility.**
4. It's the owner's responsibility to shovel snow off the canopy rooftop.
5. All containers need to be anchored to the ground in each opposite corner sides. **Customer responsibility.**
6. All of our products fall under the temporary structure category/storage ragtops.

Return Policy: Any product can be returned within 7 calendar days after arrival; shipping expenses are not refundable. For more information, please refer to the **Return and refund policy** page.

About lifespan:

Tarp lifespan: 7-10 years*

Frame Lifespan: +15 years*

****The term "lifespan" refers to the durability of the materials themselves, not to the structural integrity of the canopy once assembled.***



 990 U.S. 27 Venus, FL 33960 United States
 sales@storageandcanopy.com
 +1 (321) 710-0804
www.storageandcanopy.com

YOU MUST READ THIS DOCUMENT BEFORE YOU BEGIN TO ASSEMBLE THE SHELTER.

Thank you for purchasing our shelter. When properly assembled and maintained, this product will provide years of reliable service. These instructions include helpful hints and important information needed to safely assemble and properly maintain the shelter. Please read these instructions **before** you begin.

If you have any questions during the assembly, please contact local dealer for assistance.

SAFETY PRECAUTIONS

- . Wear eye protection.
- . Wear head protection
- . Wear gloves when handling metal tubes
- . Use a portable GFCI (Ground Fault Circuit Interrupter) when working with power tools and cords.
- . Do not climb on the shelter or framing during or after construction.
- . Do not occupy the shelter during high winds, tornadoes, or hurricanes.
- . Provide adequate ventilation if the structure is enclosed.
- . Do not store hazardous materials in the shelter.
- . Provide proper ingress and egress to prevent entrapment.

ANCHORING INSTRUCTIONS

Prior to assembling this shelter, please read the **MUST READ** document included with the shipment.

 **WARNING:** The anchor assembly is an integral part of the shelter construction. Improper anchoring may cause shelter instability and failure of the structure. Failing to anchor the shelter properly **will void the manufacturer's warranty** and may cause serious injury and damage.

LOCATION

Choosing the proper location is an important step before you begin to assemble the structure.

The following suggestions and precautions will help you determine whether your selected location is the best location.

- . Never erect the structure under power lines.
- . Identify whether underground cables and pipes are present **before** preparing the site or anchoring the structure.
- . Location should be away from structures that could cause snow to drift on or around the building
- . Do not position the shelter where large loads such as snow and ice, large tree branches, or other overhead obstacles could fall.
- . Your shelter's cover can be quickly removed and stored prior to severe weather conditions. If strong winds or severe weather is forecast in your area, we recommend removal of cover.











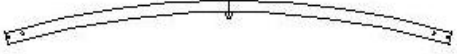
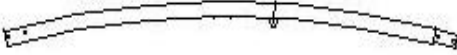

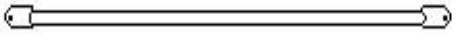
SITE

After choosing a location, proper preparation of the site is essential. The following site characteristics will help ensure the integrity of the structure.

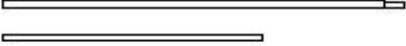
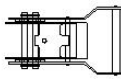
- . The support structure must be level to properly and safely erect and anchor the frame.
- . Drainage: Water draining off the structure and from areas surrounding the site should drain away from the site to prevent damage to the site, the structure, and contents of the structure.



 **WARNING:** The individuals assembling this structure are responsible for designing and furnishing all temporary bracing, shoring and support needed during the assembly process. For safety reasons, those who are not familiar with recognized construction methods and techniques **must seek the help of a qualified contractor.**

Parts List

Part Code	Description		Qty
Roof			
1	Roof Bent Joist		7
2	Middle Bent Joist		14
3	Lower Bent Joist		14
4	Purlin		30
5	Support Tube		12
6	Base Plate		12
7	Base Plate		2
8	Lower Tensioning Tube for Roof Cover, (4+1) pcs/set		2 sets
9	Winch for tensioning of roof cover (four corners)		4
10	Tube Clip with bolt M10x50 for support tube		24
11	Bolt M10x90 for swaged tube		84
12	Carriage Bolt M12x100 for purlin		35
13	End Plug		4
14	Belt for Winch on base plate		14
15	Knitting Rope for roof cover (4 bundles)		1 pack

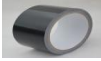

 990 U.S. 27 Venus, FL 33960 United States
 sales@storageandcanopy.com
 +1 (321) 710-0804
www.storageandcanopy.com

16	Roof Cover		1
17	Duct Tape		2
18	Expansion Bolt		42

INSTALLATION PROCESS

Note: Make sure to fix the container firmly before installing the shelter.

1. Weld base plates (No.6 & No.7) to the top of container. Please refer to the diagram (Figure 1) to mark the position of base plates.

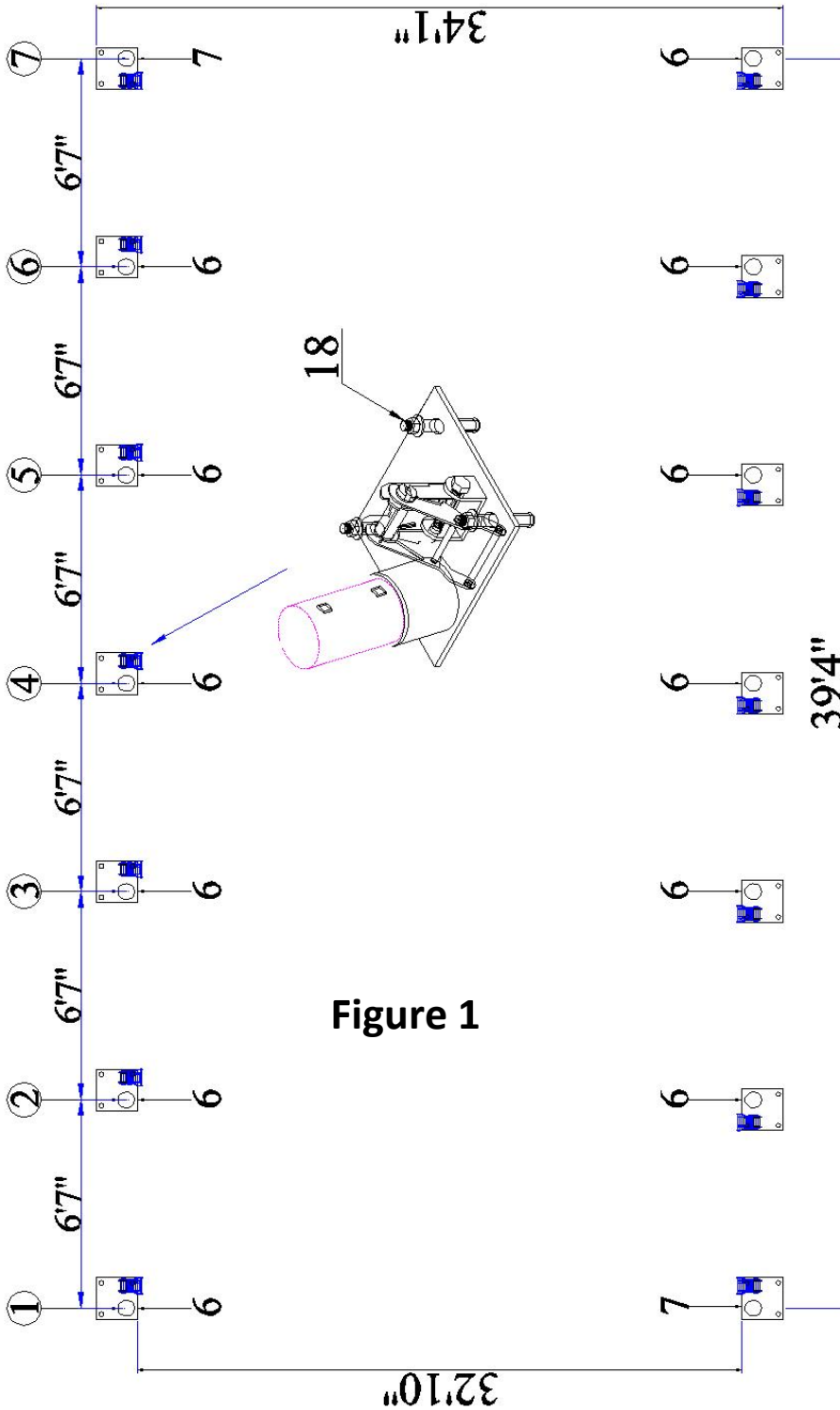
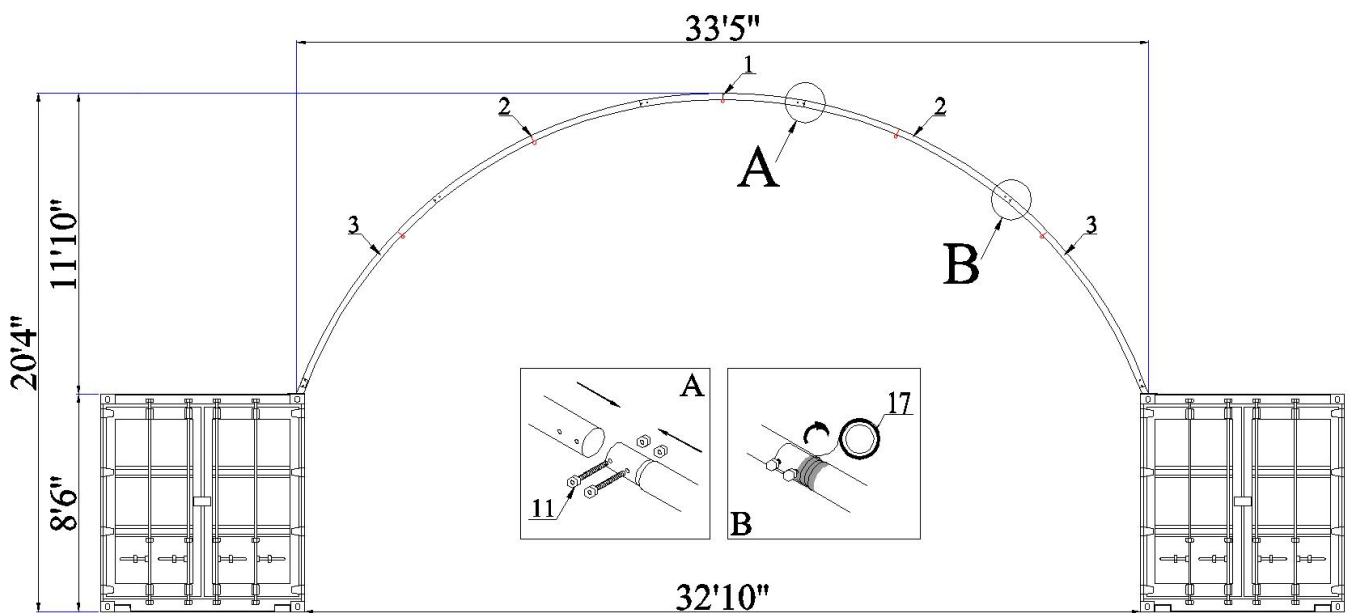

Figure 1

2. Connect the bent joist (No.1, 2, 3) by bolt M10x90 (No.11) to be one arch.
3. Put one end of the arch into the base plate (No.6 & No.7) and fasten it by bolt M10x90 (No.11), then try to put the other end into opposite base plate.
4. When 2 arches are in place, connect purlin (No.4) between them by carriage bolt M12x100 (No.12). Please note the direction of the bolt, do not leave the shaft outside where the fabric will rest. By this way, one arch and purlins between it in turn, frames are installed.
5. Install support tube (No.5) by tube clip (No.10).

Note: Before install the arch, please install the clip first.

Arch No.1 to No.7 Installation



Purlin and Support Tube Installation

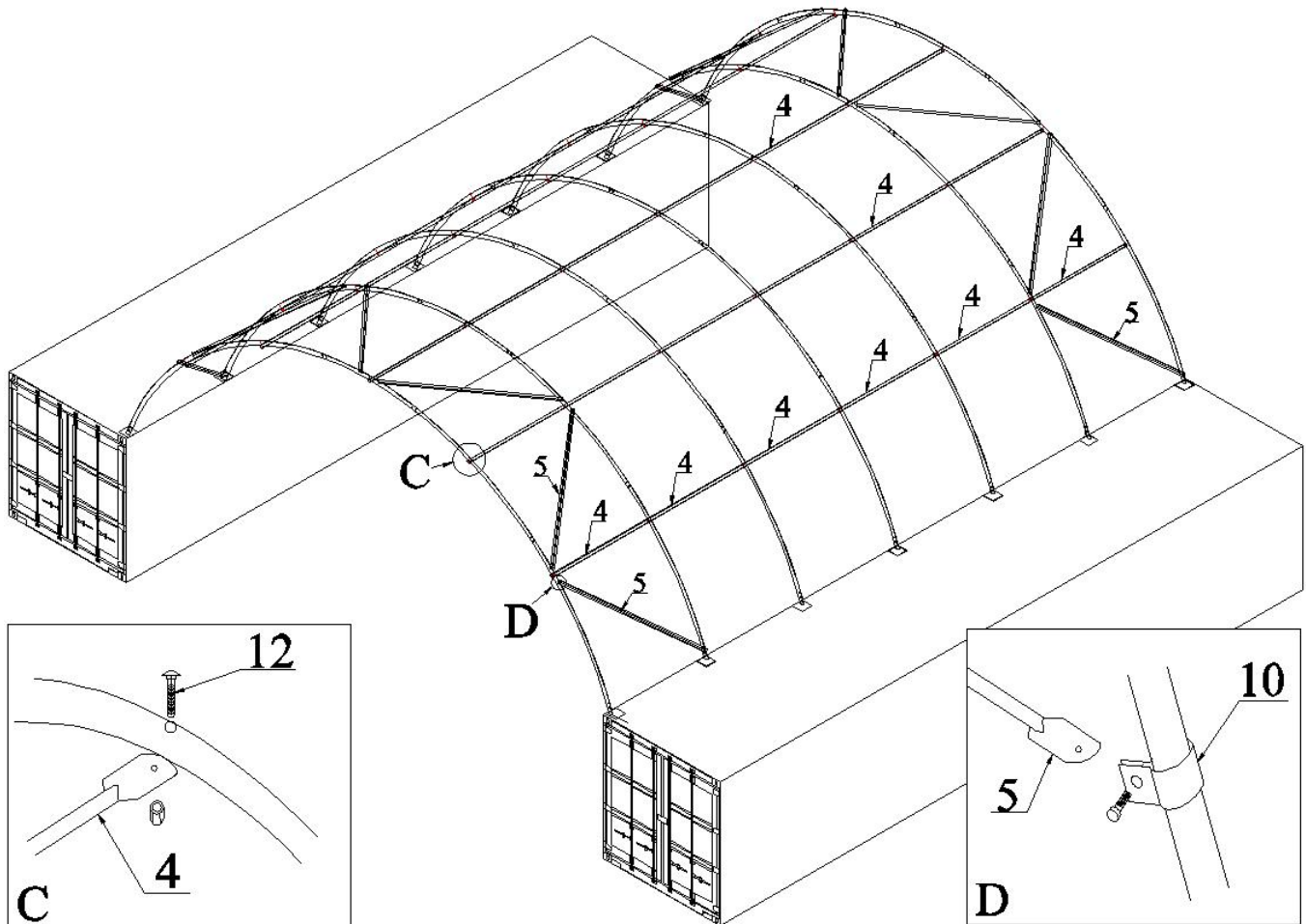

Cover Installation

1. Put the cover **EVENLY, CAREFULLY AND SLOWLY** on the frame. Insert the tensioning tube (No.8) into the cover pipe pockets and loosely secure the belt (No.14) in the winch on based plate. **DO NOT TIGHTEN**. Adjust the cover so that it is square and evenly centered on the frame.

Note: The end flaps must overhang evenly at both ends.

2. Use rope (No.15) to tighten roof cover to end arches. The rope should be cut as your requirements when using. When the cover is tidy and ready, drive the winch tie down forth and back and then roof cover is tightened. Pull the band inside the roof cover (four corners) by winch (No.9). The winches need to be welded to container.

Note: **DO NOT LEAVE COVER UNATTACHED UNDER ANY CIRCUMSTANCES** until the final assembly and tightening has been completed.

The process is quite easy. But some tightening adjustments will be necessary to produce a flat, tensioned roof cover.

Roof Cover

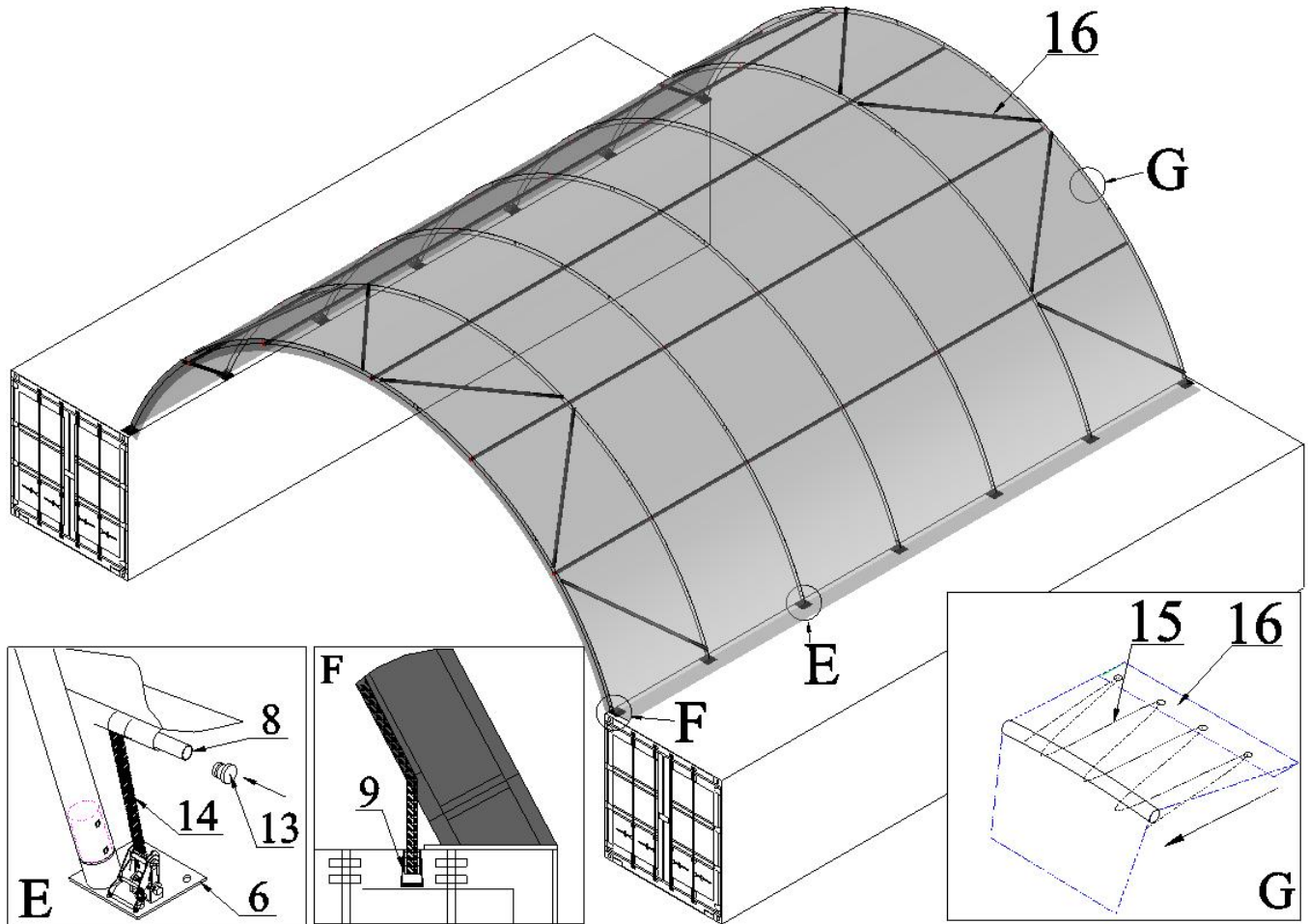

Now your installation is completed.