



990 U.S. 27 Venus, FL 33960 United States
sales@storageandcanopy.com
+1 (321) 710-0804
www.storageandcanopy.com

**Shipping Container Roof
Double Truss Round Style
Model# C4040DTR 40'x40'x15'
(8' arch space)
Assembly Instructions**



Equipment List

<p>Speed Wrench 22#.23#.24#</p>	
<p>Hammer (30lb)</p>	
<p>Rope (12#)</p>	
<p>Long Tape (50m)</p>	
<p>Hammer Drill*1</p>	
<p>Lifter*2</p>	
<p>Crane*1</p>	
<p>Forklift*1</p>	
<p>Protective equipment</p>	

ANCHORING THE CONTAINER

Make sure you have:

- Welder.
 - Cement.
 - Four 3" x 3" x 6 feet 1/4" Square steel angle
1. As shown in the diagram 1, make a 3 ft deep hole right beside one of the front and opposite rear corners of the container, in which the 6ft square steel will be installed.
 2. Insert the 6ft square steel into the hole, making sure 3ft is below the surface completely laying on the side of the containers.
 3. Weld the square steel to the 2 containers.
 4. Pour cement in the holes to make sure the square steel won't move.
 5. Repeat the previous steps on the corners located in the opposite rear side.

Securing the containers to the floor is crucial, that way the containers won't shift under harsh weather conditions, thus avoiding the shipping container canopy roof top of getting damaged.

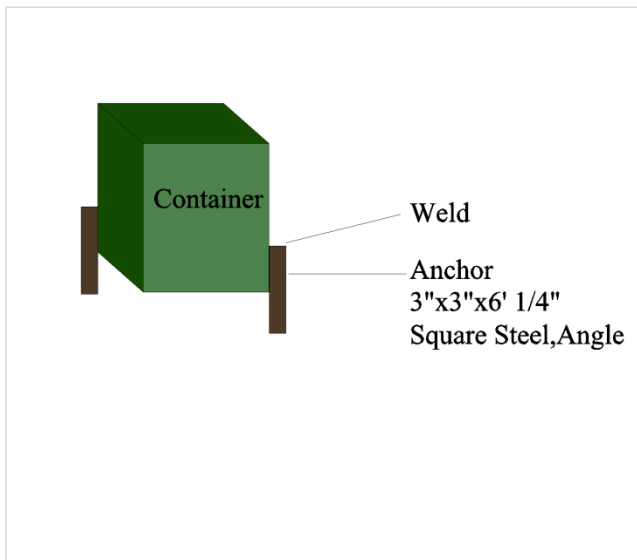

Diagram 1



Highly Recommended

1. All container canopy covers need to be removed during windstorm of 60 mph, leaving frame assembled. **Customer responsibility.**
2. All container canopy covers need to be removed before a snowstorm of 1-2 inches (for single truss Shipping container roofs) and 3-4 inches (for double truss Shipping container roofs), leaving the frame assembled. **Customer responsibility.**
3. It is highly recommended for customers who live in snow states and cities to use double truss framing instead of Single truss framing. **Customer responsibility.**
4. It's the owner's responsibility to shovel snow off the canopy rooftop.
5. All containers need to be anchored to the ground in each opposite corner sides. **Customer responsibility.**
6. All of our products fall under the temporary structure category/storage ragtops.

Return Policy: Any product can be returned within 7 calendar days after arrival; shipping expenses are not refundable. For more information, please refer to the **Return and refund policy** page.

About lifespan:

Tarp lifespan: 7-10 years*

Frame Lifespan: +15 years*

****The term "lifespan" refers to the durability of the materials themselves, not to the structural integrity of the canopy once assembled.***



YOU MUST READ THIS DOCUMENT BEFORE YOU BEGIN TO ASSEMBLE THE SHELTER.

Thank you for purchasing our shelter. When properly assembled and maintained, this product will provide years of reliable service. These instructions include helpful hints and important information needed to safely assemble and properly maintain the shelter. Please read these instructions **before** you begin.

If you have any questions during the assembly, please contact local dealer for assistance.

SAFETY PRECAUTIONS

- . Wear eye protection.
- . Wear head protection
- . Wear gloves when handling metal tubes
- . Use a portable GFCI (Ground Fault Circuit Interrupter) when working with power tools and cords.
- . Do not climb on the shelter or framing during or after construction.
- . Do not occupy the shelter during high winds, tornadoes, or hurricanes.
- . Provide adequate ventilation if the structure is enclosed.
- . Do not store hazardous materials in the shelter.
- . Provide proper ingress and egress to prevent entrapment.

ANCHORING INSTRUCTIONS

Prior to assembling this shelter, please read the **MUST READ** document included with the shipment.

⚠️ WARNING: The anchor assembly is an integral part of the shelter construction. Improper anchoring may cause shelter instability and failure of the structure. Failing to anchor the shelter properly **will void the manufacturer's warranty** and may cause serious injury and damage.

LOCATION

Choosing the proper location is an important step before you begin to assemble the structure.

The following suggestions and precautions will help you determine whether your selected location is the best location.

- . Never erect the structure under power lines.
- . Identify whether underground cables and pipes are present **before** preparing the site or anchoring the structure.
- . Location should be away from structures that could cause snow to drift on or around the building
- . Do not position the shelter where large loads such as snow and ice, large tree branches, or other overhead obstacles could fall.
- . Your shelter's cover can be quickly removed and stored prior to severe weather conditions. If strong winds or severe weather is forecast in your area, we recommend removal of cover.







SITE



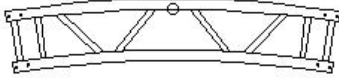
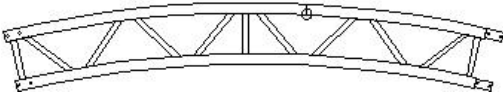
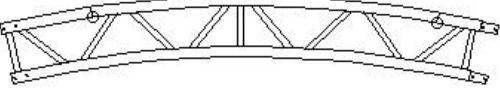
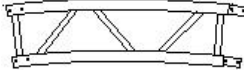
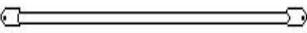

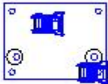
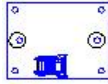

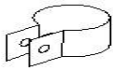
After choosing a location, proper preparation of the site is essential. The following site characteristics will help ensure the integrity of the structure.

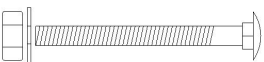
- . The support structure must be level to properly and safely erect and anchor the frame.
- . Drainage: Water draining off the structure and from areas surrounding the site should drain away from the site to prevent damage to the site, the structure, and contents of the structure.

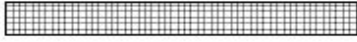
⚠️ WARNING: The individuals assembling this structure are responsible for designing and furnishing all temporary bracing, shoring and support needed during the assembly process. For safety reasons, those who are not familiar with recognized construction methods and techniques **must seek the help of a qualified contractor.**

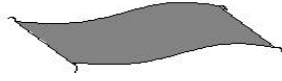
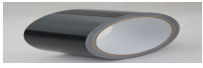
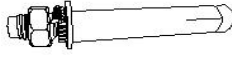
Parts List

Part Code	Description	Qty/PCS
Roof		
1	Top Truss Arch	 6
2	Upper Truss Arch	 12
3	Middle Truss Arch	 12
4	Lower Truss Arch	 12
5	Purlin	 35
6	Connection Plate for steel wire No.21	 16
7	Base Plate (four corners with winch)	 4
8	Base Plate (inner with winch)	 8
9	Lower Tensioning Tube for Roof Cover, (4+1) pcs/set	 2 sets
10	Tube Clip with bolt M10x50 for support tube No.5	 32
11	Bolt M8x70 for swaged tube	 192
12	Carriage Bolt M10x80 for purlin	 42

13	End Plug		4
14	Belt for winch		12
15	Knitting Rope for roof cover (4 bundles)		1 pack
16	Roof Cover		1
17	Duct Tape		2
18	Expansion Bolt		48
19	Turnbuckle		16
20	Steel Wire Clamp		32
21	Steel Wire		16

INSTALLATION PROCESS

Note: Make sure to fix the container firmly before installing the shelter.

A—BASE PLATES INSTALLATION

Please refer to the diagram (Figure 1) to mark the position of base plates

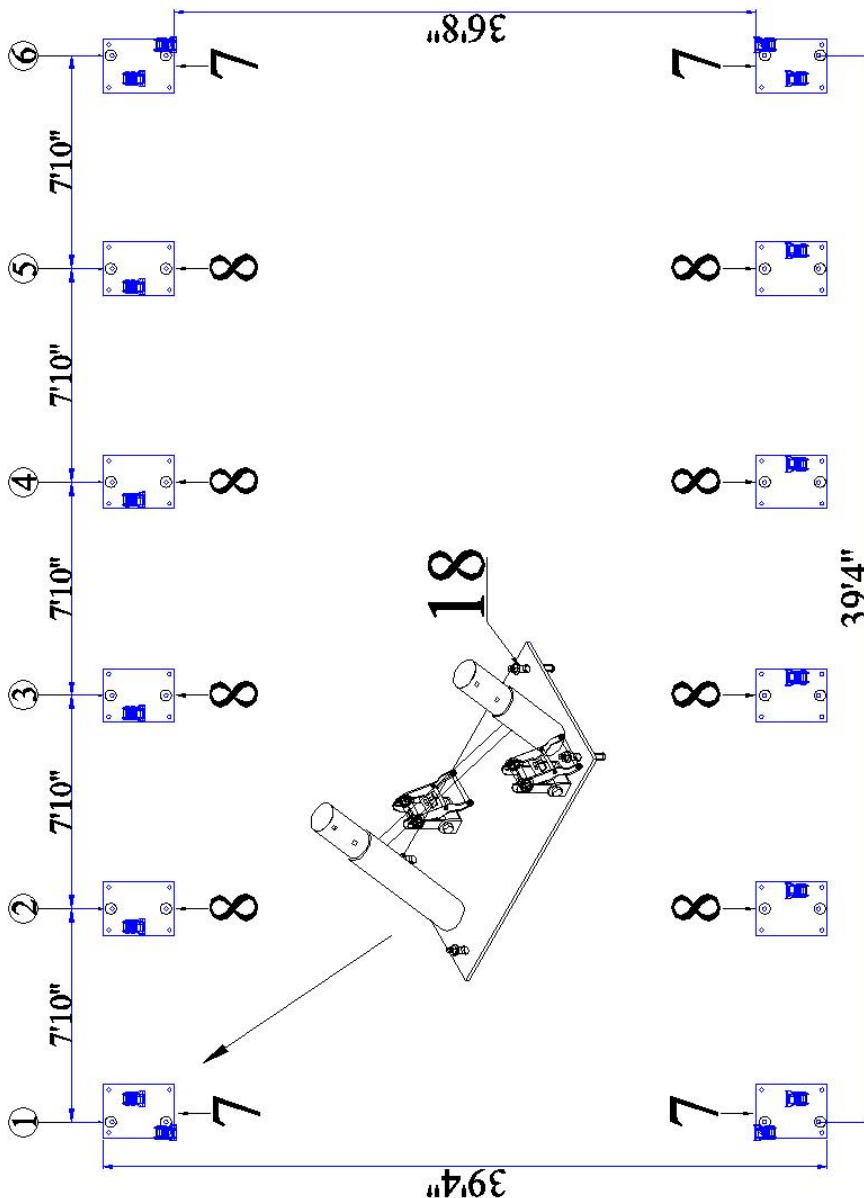
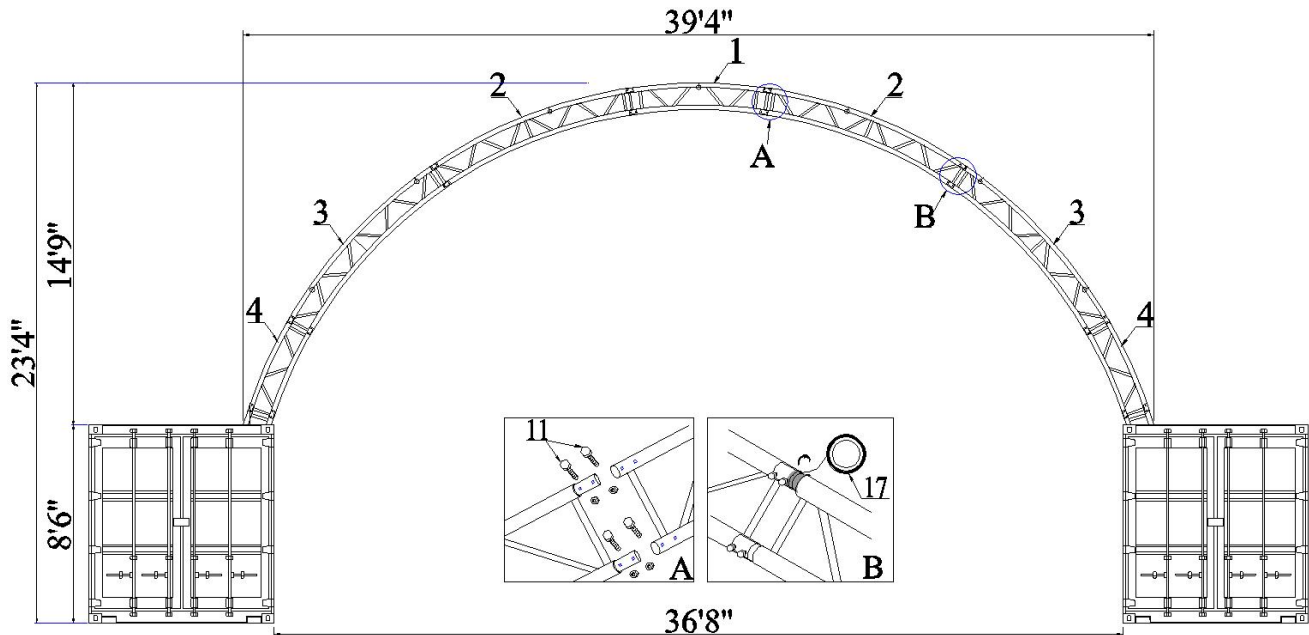

Figure 1

1. The measurement is done as the above figure 1 showing. Referring to the above diagram and confirm the place of base plates. **ENSURE THAT THE FOUNDATION IS SQUARE.**
2. The Four corners base plate (No.7) and the middle base plate (No.8) are welded on the top of container.

B—FRAME INSTALLATION

1. Arch Installation: Find Truss Arches (No.1, 2, 3, 4) and Base Plate (No.7 & 8) and connect them by Bolt M8x70 (No.11).



Purlins and Support Tubes

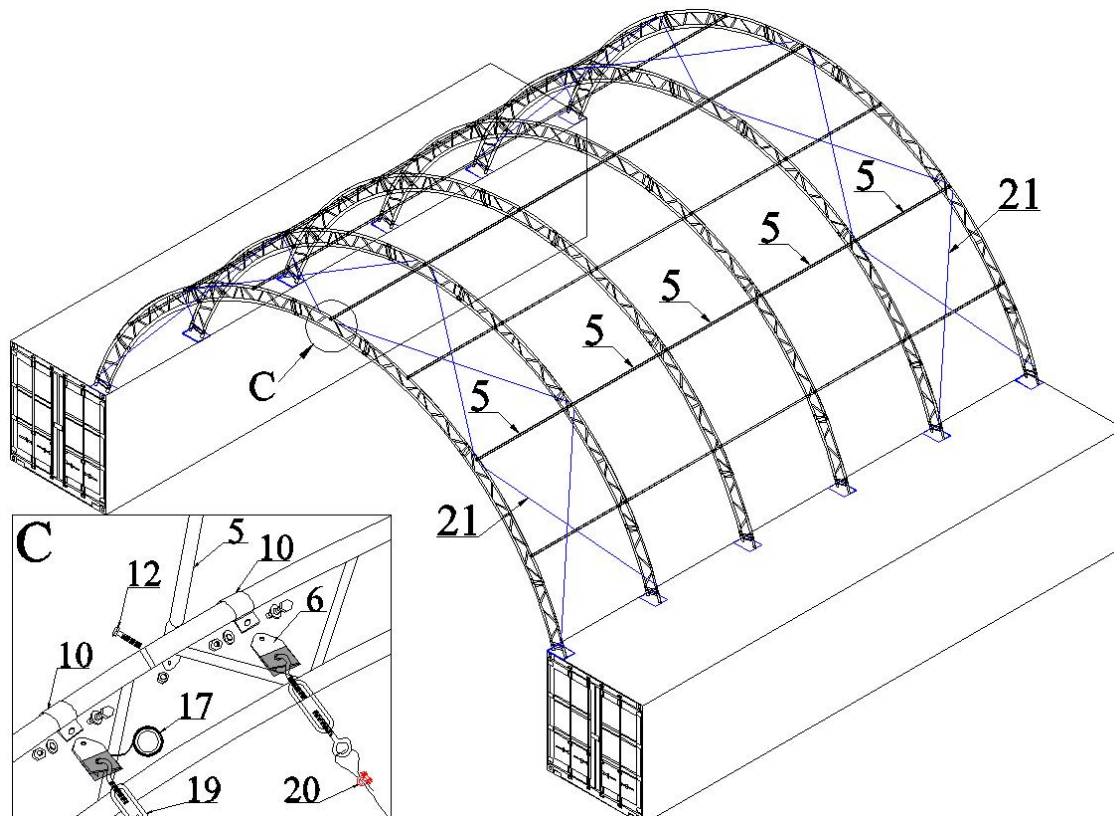



2. When finish installing all arches, lift the arch to top of containers, and then adjust the distance between arches. Weld the base plate to container firmly.
3. Install Purlin (No.5) by Carriage Bolt M10x80 (No.12) and then the third arch and Purlins. In this turn, one arch and then purlin tubes.
4. Install Steel Wire (No.21) between arches by Tube Clip (No.10), Connection Plate (No.6), Turnbuckle (No.19) and Steel Wire Clamp (No.20).

IMPORTANT: THE WIDTH OF ARCHES SHOULD BE ADJUSTED BEFORE LIFTING.

C—COVER INSTALLATION

NOTE: DO NOT install the cover onto the frame of your building in high wind conditions. A slight breeze is the most advantageous for cover installation. To take advantage of the breeze, pull the cover up over the arches with the breeze blowing in the cover like a sail filled with air.

1. Roll out the roof cover on a ground sheet. Align the cover evenly to each end of the frame. Be sure doing not over pull the end of the roof cover.
2. Insert the Tensioning Tubes (No.9) into the cover pipe pockets. Pull the cover over the frame EVENLY, CAREFULLY AND SLOWLY. Cut openings on the pocket above the corresponding base plate and loosely secure the Belt (No.14) in the Winch (being installed on base plates). DO NOT TIGHTEN. Adjust the cover so that it is square and evenly centered on the frame.

Note: The end flaps must overhang evenly at both ends.

3. Use Rope (No.15) to tighten roof cover to end arches. Rope should be cut as your requirements when using. When the cover is tidy and ready, drive the winch tie down forth and back and then roof cover is tightened. Pull the band inside the roof cover (four corners) by Winch on base plate (No.7).

Note: if there is damage for cover when use, please repair it as soon as possible to avoid further damage.

Roof Cover Installation

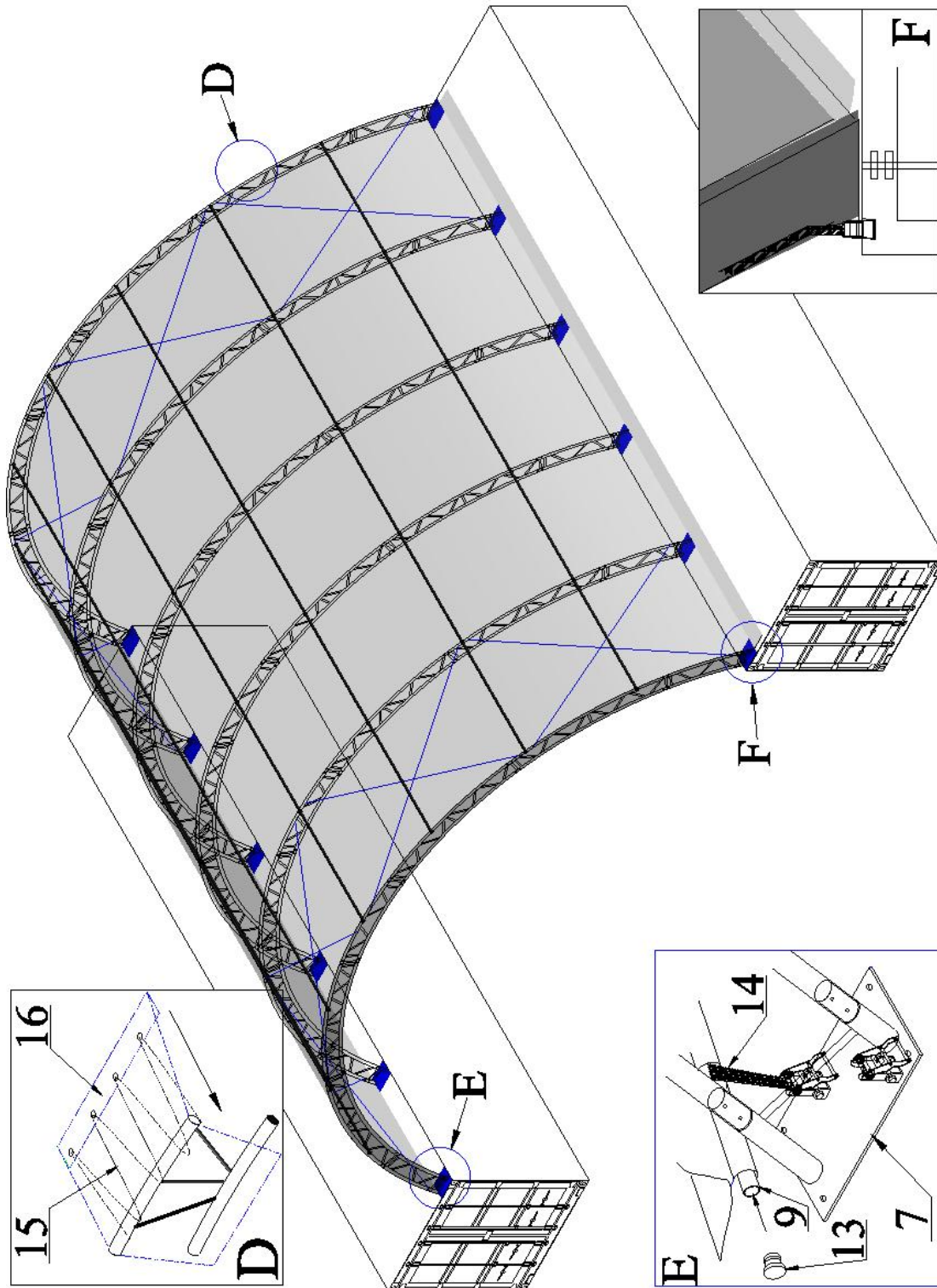

Now your assembly is completed.